



Makinex 23kVA Generator

GEN-23P-AU

- 2x15A + 1x32A 3-Phase Outlet



OPERATOR'S MANUAL

Rev 0320

Table of Contents

INTRODUCTION	1
DISCLAIMER	1
ABOUT THIS MANUAL.....	2
SAFETY INFORMATION	3
GENERAL SAFETY INFORMATION	3
EARTHING OF GENERATOR	6
GENERAL SAFETY DECAL	7
PRODUCT SPECIFICATIONS	8
FEATURES	9
OVERALL MACHINE DIMENSIONS.....	10
ALTERNATOR SPECIFICATIONS	10
INSTRUCTION FOR USE	11
BEFORE USE	11
OPERATING GENERATOR	13
MAINTENANCE	14
GENERAL RECOMMENDATIONS:.....	14
GENERAL TROUBLESHOOTING	15
STORAGE.....	16
LIMITED WARRANTY	17
WARRANTY EXCLUSIONS.....	18
OWNER'S RESPONSIBILITY UNDER LIMITED WARRANTY:.....	19
CONTACT INFORMATION	20
APPENDICES	21
APPENDIX A – WIRING CIRCUIT DIAGRAM	21
APPENDIX B – RISK ASSESSMENT	22

INTRODUCTION

Thank you for purchasing a MAKINEX product.

This manual provides information and procedures to safely operate and maintain the **GEN-23P** Generator. For your own safety and protection from injury, carefully read, understand, and observe the safety instructions described in this manual.

Keep this manual or a copy of it with the machine. If you lose this manual or need an additional copy, please contact MAKINEX. This machine is designed and built with user safety in mind; however, it can present hazards if improperly operated and serviced. If there are any questions regarding operating or servicing of this machine, please contact MAKINEX.

All rights, especially copying and distribution rights are reserved.

Copyright 2020 by MAKINEX.

No part of this publication may be reproduced in any form or by any means, electronic or mechanical, including photocopying, without express written permission from MAKINEX.

Any type of reproduction or distribution not authorised by MAKINEX represents an infringement of valid copyrights and will be prosecuted. We expressly reserve the right to make technical modifications, even without due notice, which aim at improving our machines or their safety standards.

DISCLAIMER

MAKINEX and its affiliates take no responsibility for any damage, injury or death resulting from the incorrect or unsafe use of this product. Use of this product should be undertaken by competent persons only. It is the operator's responsibility to ensure that the following safety procedures are followed. If you are unsure, do not operate this product.

Record the model and serial numbers as well as date and place of purchase for future reference. Have this information available when ordering parts and when making technical or warranty inquiries.

MAKINEX SUPPORT

Refer to contact details on pg. 20

MODEL NO.

GEN-23P-AU

SERIAL NO.





DATE OF PURCHASE

PURCHASE LOCATION

ABOUT THIS MANUAL

This manual uses the following symbols to help differentiate between different kinds of information. The safety symbol is used with a key word to alert you to potential hazards in operating and owning power equipment. Follow all safety messages to avoid or reduce the risk of serious injury or death.

KEY TERMS

 READ CAREFULLY	READ CAREFULLY – refers to <i>important information</i> that should be paid careful attention.
 CAUTION	CAUTION - indicates a potential hazardous situation which, if not avoided, <i>may</i> result in minor or moderate injury
 WARNING	WARNING – indicates a potentially hazardous situation which, if not avoided, <i>could</i> result in death or serious injury
 DANGER	DANGER – indicates an imminently hazardous situation which, if not avoided, <i>will</i> result in death or serious injury
 PROHIBITED	PROHIBITED – identifies actions that <i>should never</i> be carried out by anyone interacting with the machine.

These safety warnings do not eliminate all possible hazards that could occur therefore it is essential to use common sense and to strictly follow any instructions to prevent accidents.

SAFETY INFORMATION

GENERAL SAFETY INFORMATION

 WARNING	Read this manual thoroughly before operating your generator. Failure to follow instructions could result in serious injury or death.
---	---

 WARNING	MAKINEX GEN-23P Generator designed for professional operators only, instruct operators in care and use of the machine before use!
---	---

 WARNING	Keep children away from the generator at all time.
---	--

- **ALWAYS** use in a well-ventilated area.
- **ALWAYS** have someone alert attending the machine.
- **ALWAYS** wear hearing protective equipment whilst in operation.
- **ALWAYS** ensure the applied load does not exceed the generators rating.
- **ALWAYS** disconnect the generator when carrying out any maintenance.
- **ALWAYS** ensure the generator reaches operating speed before connecting a load.
- **ALWAYS** start the engine **BEFORE** connecting any appliances to the output receptacles.
- **ALWAYS** test the RCBO's before use.
- **ALWAYS** check the generator for damage before use.
- **ALWAYS** keep well clear of all moving parts on the generator.
- **NEVER** allow children or animals near the generator.
- **NEVER** connect to a commercial or mains power supply, or any other electrical source.
- **NEVER** allow the generator to run out of fuel when a load is connected.
- **NEVER** use accessories or attachments not recommended by MAKINEX.
- **NEVER** alter or tamper with the internal wiring of the generator.
- **NEVER** operate in wet conditions.
- **NEVER** climb or stand on the generator as dents may cause overheating of the acoustic lining.

 DANGER	RISK OF HOT SURFACES
	<ul style="list-style-type: none">• Contact with hot surfaces, such as engine's exhaust components, could result in serious burns.• During operation, touch only the control surfaces of generator.

- **NEVER** touch any part of the engine, alternator, or exhaust when the generator is in use or immediately after use, as these get hot and could burn.

 DANGER	RISK TO BREATHING
	<ul style="list-style-type: none">• Running engine gives off Carbon Monoxide, an odourless, colourless, poisonous gas.• Breathing Carbon Monoxide can cause nausea, fainting or death.• Some chemicals or detergents may be harmful if inhaled or ingested, causing severe nausea, fainting, or poisoning.



 DANGER	EXHAUST FUMES CAN BE FATAL	 TOXIC HAZARD
--	-----------------------------------	--

- **ALWAYS** ensure that there is adequate ventilation when using the generator.
- **ALWAYS** position the generator so that the exhaust is pointing away from people or animals.
- **NEVER** use the generator indoors or in an enclosed area.

GENERATOR POSITIONING FOR SAFE USE



- **ALWAYS** leave at least a 1 metre (3 foot) gap between the generator and any surrounding building or structure.
- **ALWAYS** ensure the generator is on a solid, flat surface.
- **ALWAYS** ensure the surrounding area is free from any material that could burn or be damaged by heat.
- **NEVER** move or tilt the generator whilst it is switched on.
- **NEVER** cover or enclose the generator whilst it is in use.
- **NEVER** use the generator at an incline above 20° otherwise the engine will malfunction whilst in operation.
- **NEVER** attempt to lift or move the generator without the assistance of other persons or suitable lifting equipment.

ELECTRICITY RELATED SAFETY PRECAUTIONS

 WARNING	RISK OF ELECTRICAL SHOCK <ul style="list-style-type: none">• Risk of electrocution	 ELECTRICAL HAZARD
---	---	---

- **ALWAYS** test the RCBOs before use.
- **ALWAYS** store the generator undercover when not in use and away from damp or wet conditions.
- **ALWAYS** disengage the battery when performing any maintenance.
- **NEVER** try to repair electrical components if not authorised or qualified.
- **NEVER** use the generator outdoor when it is raining or snowing or in wet or damp conditions.
- **NEVER** use water or any other liquids to clean the unit while it is running.
- **NEVER** use any damaged electrical cord sets with the generator.

FIRE -RELATED SAFETY PRECAUTIONS

 DANGER	RISK OF EXPLOSION OR FIRE <ul style="list-style-type: none">• Fuel and its vapours are extremely flammable and explosive• Fire or explosion can cause severe burns or death	 FIRE HAZARD
--	---	---

- **ALWAYS** switch the engine **OFF** when refuelling.
- **ALWAYS** refuel away from any source of heat.
- **ALWAYS** refuel in a well-ventilated area.
- **ALWAYS** keep a fire extinguisher in the vicinity at all time
- **NEVER** overfill fill the tank, fill to the level specified to allow for fuel expansion.
- **NEVER** smoke or use a naked flame near the generator.
- **NEVER** start the engine if there is a fuel spill. Any spillage must be wiped clean and the generator allowed to dry before attempting to start the engine.
- **NEVER** leave any combustible materials near the generator.

EARTHING OF GENERATOR

Earthing of generators helps protect the user from electric shock or electrocution which may be caused due to malfunction or breakdown. This threat to the user is prevented by creating a path of least resistance for the electrical current to travel to the ground which inherently absorbs the over-current or short circuit.

The appropriate measures for earthing the portable generator are already in place however, the user should always inspect the earthing system before use.



DO NOT TOUCH ANY COMPONENTS IF YOU ARE NOT A QUALIFIED ELECTRICIAN.



FAILURE TO PROPERLY CONNECT THE EQUIPMENT TO THE EARTHING CONDUCTOR WILL RESULT IN A RISK OF ELECTROCUTION. CONSULT WITH A QUALIFIED ELECTRICIAN IN CASE OF DOUBT WITH THE EARTHING OF THE UNIT.

Referring to the example image, there are a few components that should be observed.

- Frame
- Green/yellow earth wire
- Nut and screw

Ensure both wires are secured with the nuts and screw onto the frame.

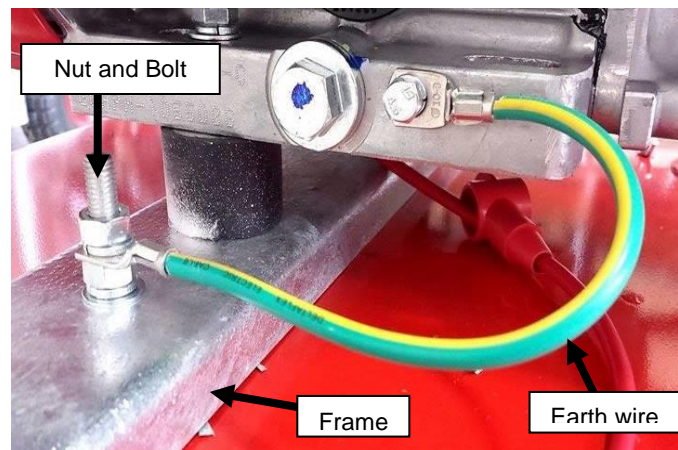

READ CAREFULLY

ANY OTHER GROUNDING INSTALLATION MUST BE CARRIED OUT BY A LICENSED ELECTRICIAN AND ALL LOCAL CODES MUST BE FOLLOWED.

We strongly recommend that all applicable federal, state, and local regulations relating to grounding/earthing specifications be checked and followed.

GENERAL SAFETY DECAL

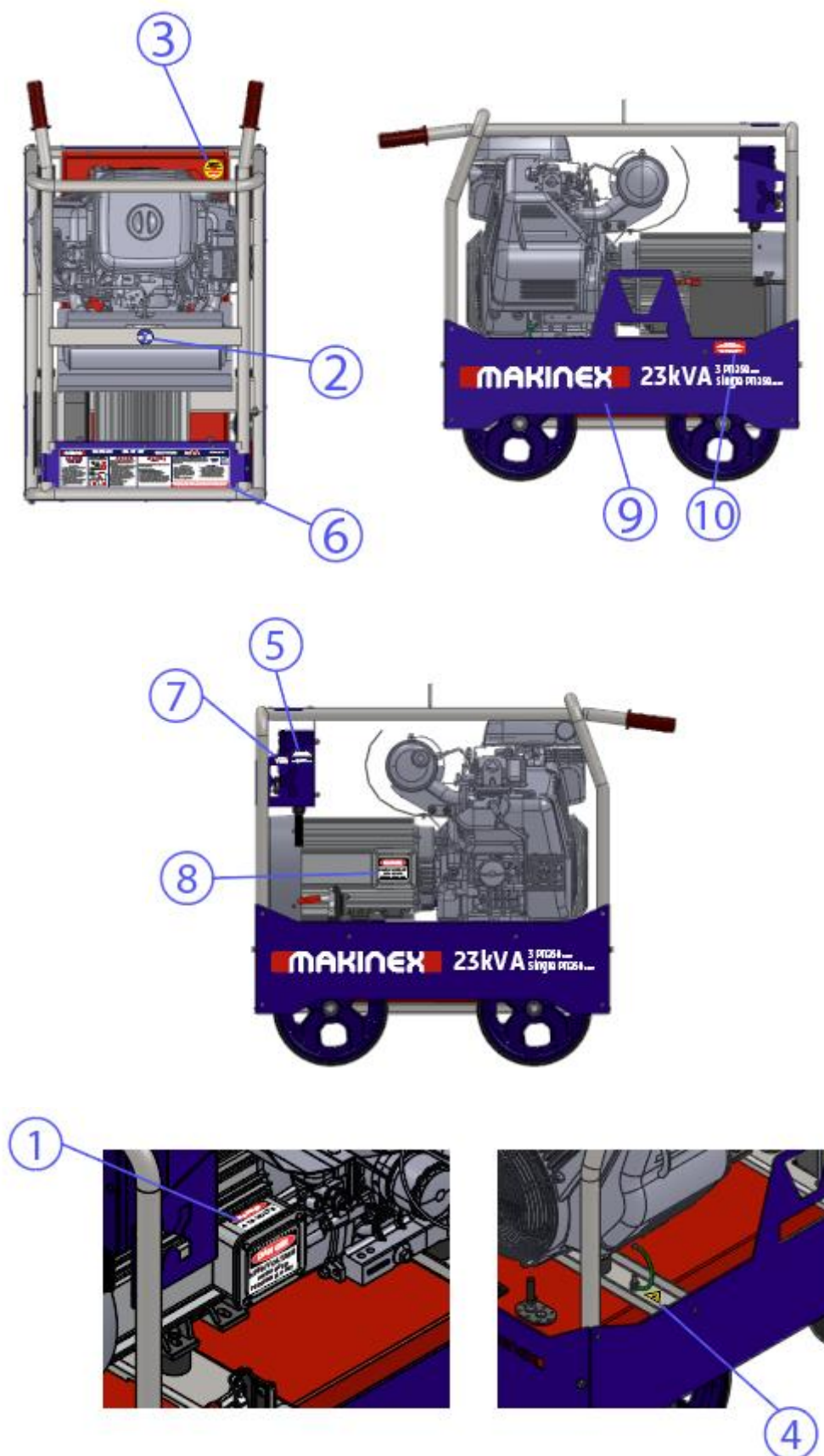

1



2



3



4



6

MAKINEX GEN-23P-AU-415 23kVA 415V 240V		ENGINE 093cc Vanguard EFI Petrol	FUEL TANK 50 L / 13 Gal	makinex.com.au	
<p>⚠ DANGER</p> <p>CARBON MONOXIDE POISONOUS GAS See Manual</p> <ul style="list-style-type: none"> Use generator outdoors, away from open windows, vents, or doors. Generator exhaust contains carbon monoxide - a poisonous gas that can kill you. You CAN NOT smell or see this gas. Never use a generator in enclosed or partially-enclosed spaces. Install battery-operated carbon monoxide alarms or plug-in carbon monoxide alarms with battery back-up in your home. 	<p>USE OUTDOORS AVOID CARBON MONOXIDE POISONING</p>	<p>⚠ DANGER</p> <p>Failure to follow warnings, instructions and operators manual could result in death or serious injury.</p> <p>GENERATOR COULD CAUSE ELECTRICAL SHOCK</p> <ul style="list-style-type: none"> Do not run indoors to avoid wet conditions Do not run in rain or wet weather Transfer switch must be used when connecting to a home's electrical system <p>HOT EXHAUST GASES COULD CAUSE FIRES. KEEP AT LEAST 5FT (1.5M) CLEARANCE FROM ANY COMBUSTIBLES OR STRUCTURES, INCLUDING OVERHEAD.</p> <ul style="list-style-type: none"> Point muffler away from home Do not touch hot parts Avoid hot exhaust gases 	<p>⚠ WARNING</p> <p>SHOCK</p> <p>A generator is a potential shock hazard which can result in serious injury or death.</p> <ul style="list-style-type: none"> Generator must be kept dry. Do NOT operate unit with wet hands. Generator MUST be grounded before use. See operators manual for specific instructions. Use extreme caution when refuelling unit. Always keep generator four (4) feet from any structure. Always remove refueling gas can from generator area. This generator has an internal link between the neutral conductor and the earthed frame of the generator. 	<p>OPERATION</p> <p>Read operator's Manual carefully before operating unit. Always make sure unit is level and properly grounded. Check battery oil before starting. See instructions located in operator's manual for starting procedure.</p> <p>START-UP</p> <ol style="list-style-type: none"> Turn the engine key to the START position, hold until engine starts. When the engine starts, release key, allowing it to return to the ON position. Allow unit to run two (2) minutes to warm up. <p>Loads can now be applied to unit.</p> <p>SHUT-DOWN</p> <ol style="list-style-type: none"> Remove all load by turning off electrical appliances and unplugging electric cords. Allow engine to run with no load to cool for two (2) minutes. Not allowing engine to cool may result in damage to unit. Turn the engine key to the OFF position. 	<p>SCAN OR CODE TO FIND OUT MORE</p>
<p>IMPORTANT: For maximum battery life, please recharge the battery every 3 months or when the battery voltage is less than 12.6V. Isolate battery if not in use for extended periods.</p>					

9



5

MAKINEX
CONSTRUCTION PRODUCTS

For service and support
1300 795 953
service@makinex.com.au

7

MAKINEX
CONSTRUCTION PRODUCTS

W makinex.com.au E sales@makinex.com.au

SERIAL NUMBER

8



10

IMPORTANT:
For maximum battery life,
please recharge the battery every
3 months or when the battery
voltage is less than 12.6 V

PRODUCT SPECIFICATIONS

GENERATOR:	
MAX OUTPUT	23kVA (18.4kW)
RATED FREQUENCY	50Hz
RATED POWER FACTOR	0.8
OUTLET SOCKETS (all with RCBO PROTECTON)	2 X 15A SINGLE PHASE + 1 X 32A 3PHASE SOCKETS
DRY WEIGHT	240KG
DIMENSIONS	1105 x 641 x 1008 mm LENGTH x WIDTH x HEIGHT APPROX
NOISE LEVEL (7m)	50% LOAD – 80dB
ENGINE:	
TYPE	TWIN CYLINDER AIR COOLED PETROL
MODEL	VANGUARD 61E377
STARTING SYSTEM	ELECTRIC KEY START
DISPLACEMENT	993CC
FUEL ECONOMY	5.7L/h @ 50% LOAD
FUEL TANK	50 L

FEATURES

FEATURES
Durable Galvanised frame
Multi cushion isolators for vibration reduction
Compact design for easy storage and transport
Lifting point for transportation
RFL permanent magnet alternator

OVERALL MACHINE DIMENSIONS

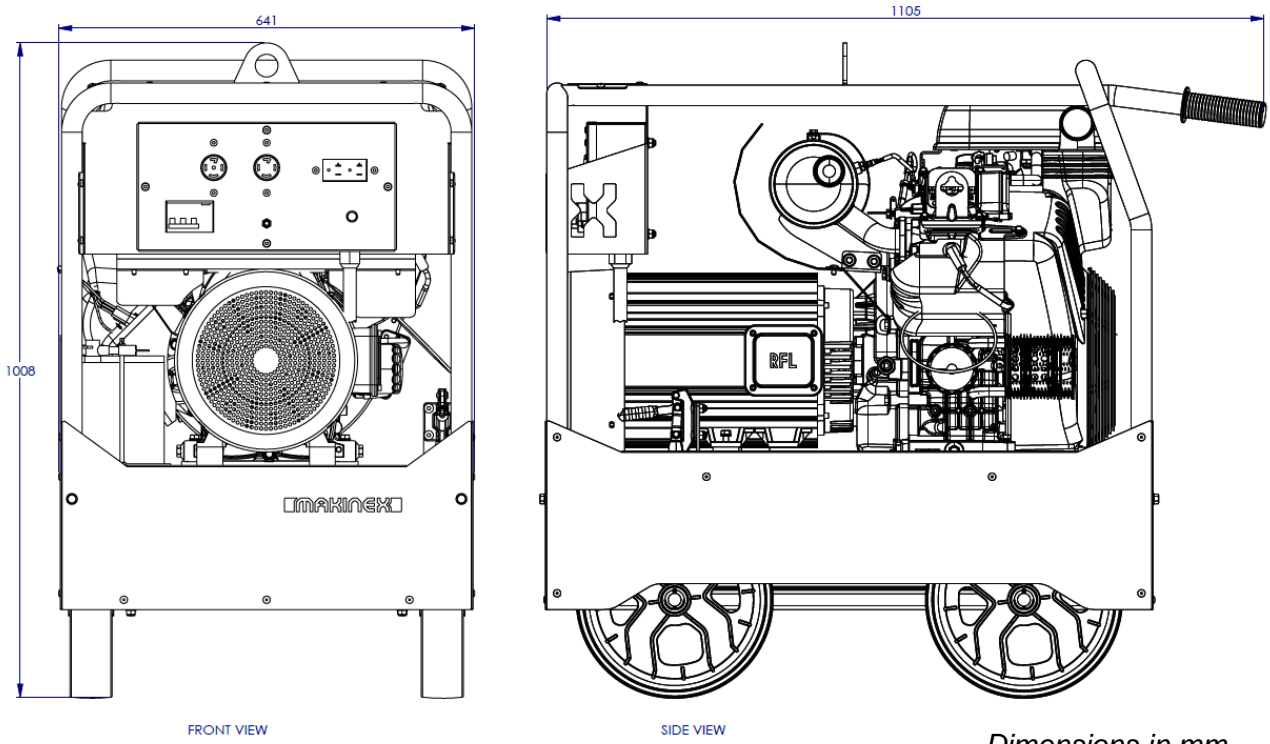

ALTERNATOR SPECIFICATIONS

RFL ALTERNATORS		RFL Alternators	
http://www.rflalternators.com			
Frame	132	Type	RF2 - 27.5 - 2
Enclosure	IP23	PM Brushless Alternator	
Poles	2	Phase	3
RPM	3000	Volts	400/420
Frequency	50 Hz	Amps	31
Power	22.0	Motor Start kVA	
Weight (kg)		Short Cir Amps	
Ref Temp	27°C	Serial No.	P2001-001
CE		EC.1282.OP190523.RFLDQ73	

INSTRUCTION FOR USE



Read and adhere to all safety and operation instructions.

BEFORE USE

Before using the generator, ensure all the safety and operation instructions are read and the following steps are performed.

OIL LEVEL CHECK



Check the engine oil level with the engine stopped and in a levelled position

1. Check the engine oil level with the engine stopped and, in a levelled position.
2. Start the engine and let it idle for 1 or 2 minutes. Stop the engine and wait for 2 or 3 minutes.
3. Remove the oil level dipstick and wipe it clean.
4. Fully insert the oil level dipstick, then remove it to check the oil level.
5. If the oil level is low, remove the oil filler cap, and fill with the recommended oil to the upper limit mark on the oil level dipstick.
6. Reinstall the oil level dipstick and oil filler cap

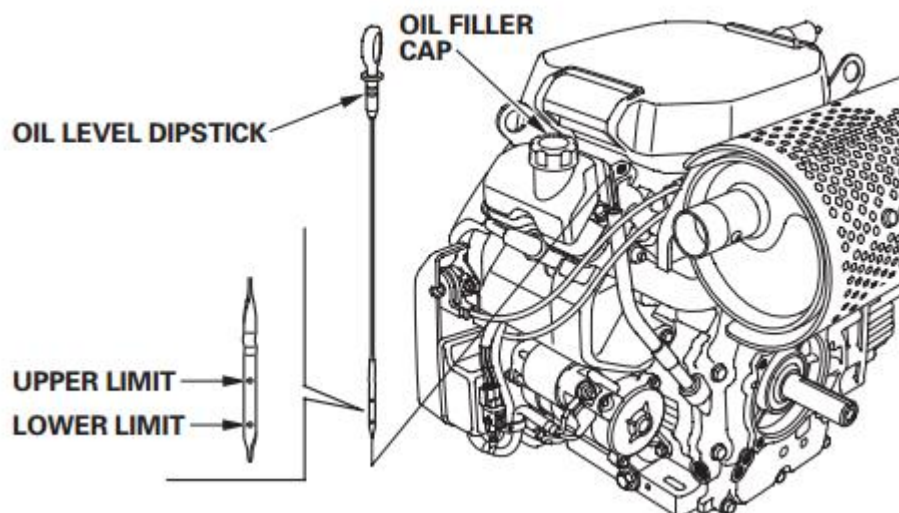

NOTE: New machines will be pre-oiled from MAKINEX with:
Power Equipment Engine Oil – SAE 10W-30, API SJ

REFUELING



FAILURE TO USE FUEL AS RECOMMENDED IN THIS MANUAL WILL VOID WARRANTY

- **DO NOT** use unapproved gasoline such as ethanol-based fuel.
- **DO NOT** mix oil with gasoline.
- **DO NOT** modify engine to run on alternate fuels.



Fuel and fuel vapour are extremely flammable and explosive. Fire or explosion from misuse of fuel can cause severe burns and even death.



FIRE HAZARD



Always ensure that fuel tanks are filled outdoors.

1. Turn generator **OFF** and let it cool for at least two minutes before removing fuel cap.
2. Loosen fuel cap slowly to release pressure.
3. Slowly add unleaded gasoline to fuel tank. **DO NOT** fill fuel above baffle to allow for appropriate space fuel expansion.
4. Wait for spilled fuel to evaporate before starting the engine.



Keep fuel away from sparks, open flames, pilot lights, heat and other ignition sources.

DO NOT light a cigarette or smoke near open fuel tank or container.



OPERATING GENERATOR



Read and adhere to all safety and operation instructions.



Always have the brake down while it is stationary.

STARTING THE GENERATOR

1. Remove all connections from the AC sockets.
2. If the fuel tank is equipped with a valve, be sure the fuel valve is in the OPEN or ON position before attempting to start the engine.
3. Turn the engine switch to the START position and hold it there until the engine starts.
4. When the engine starts, release the engine switch, allowing it to return to the ON position.

CONNECTING ELECTRICAL DEVICES

The generator can supply 240V AC through 2 x 15amp sockets and 415V AC through the 32A socket.

1. Connect the appliance to the generator starting with the device that draws the most current.
2. Set the circuit breaker to 'ON'.

SHUTTING DOWN THE GENERATOR

1. Disconnect all appliances connected to the generator.
2. Allow to cool for two (2) minutes under no load.
3. Turn the ignition key to the OFF position.

NOTE: To stop the generator in an emergency simply turn the ignition key to the off position.

MAINTENANCE

GENERAL RECOMMENDATIONS:

Regular maintenance will improve the performance and extend the life of the generator.

The generator's warranty does not cover items that have been subjected to operator abuse or negligence. To receive full value from the warranty, the operator must maintain the generator as instructed in this manual and in the **Vanguard 61E377** user manual, including proper storage and regular servicing.



**READ
CAREFULLY**

Regular maintenance is required to ensure performance of generator and to ensure warranty is not voided.

The maintenance schedule is in the Vanguard 61E377 owner's manual.

Should you have questions about replacing components on your generator, please contact dealer for assistance. MAKINEX dealers have access to all the special tools, technical information, parts and training required to maintain your MAKINEX product in peak operating condition.

GENERAL GENERATOR CHECKS

It is considered good practise to check the generator before and after use, looking at:

- Function of brake
- Condition of electrical components (especially RCBOs)
- Earthing bolts are tight
- Condition of engine mounts
- Fuel lines conditions
- Oil and fuel levels
- Battery is well secured, and terminals are fastened tightly
- Hour meter
- Any possible leaks

GENERAL TROUBLESHOOTING

PROBLEM	POSSIBLE CAUSES	CORRECTIONS
ENGINE WILL NOT START	Out of fuel.	Add fresh fuel.
	Wrong fuel.	Drain fuel tank and then add fresh fuel.
	Low engine oil.	Fill up with oil.
	Low battery.	Charge the battery.
	Engine requires servicing.	Contact authorised Makinex dealer
ENGINE LACKS POWER	Stale fuel.	Drain fuel tank and then add fresh fuel.
	Dirty air filter.	Replace or clean air filter.
	Generator is overloaded.	Reduce the load.
	Fault in alternator.	Contact authorised Makinex dealer
	Engine requires servicing.	Contact authorised Makinex dealer
ENGINE IS RUNNING BUT NO AC OUTPUT	Circuit breaker tripped	Unplug all appliance from sockets and reset the circuit breaker.
	Faulty appliance.	Connect with another appliance that is in good condition.
	Fault in generator	Contact authorised Makinex dealer
UNIDENTIFIED	Contact authorised Makinex dealer for assistance.	

For other engine problems or further instructions, refer to the provided Vanguard 61E377 user manual.

STORAGE

STORAGE WITH FUEL IN TANK

Gasoline fuel can become stale when stored over **30 days**. Stale fuel causes acid and gum deposits to form in the fuel system or crucial carburettor parts. To keep fuel fresh:

1. Add a fuel stabiliser liquid additive to fuel.
2. Run engine for a minimum of 2 minutes to allow it to circulate throughout the engine



Fuel and fuel vapour are extremely flammable and explosive. Fire or explosion from misuse of fuel can cause severe burns and even death.



RUST PREVENTION IN CYLINDERS

1. Remove spark plugs and pour approx. 15ml (1/2oz) of clean engine oil into the cylinder.
2. Install spark plug and briefly turn the key starter for 1-2 seconds to distribute oil.
DO NOT start engine at this time.



Unintentional sparking can cause fire or electrical shock. Failure to observe this warning can cause severe property damage, severe burns and even death.

Disconnect spark plug wire from spark plug and cover tip of spark plug wire with insulating tape and place wire where it cannot come in contact with spark plug or generator frame.



Certain storage covers can be flammable or can melt in high temperatures. **DO NOT** place storage cover over generator until it has completely cooled.

BATTERY STORAGE PRECAUTIONS

After use of the generator, follow these precautions to ensure the battery does not drain whilst in storage or not in use.

1. Check the key ignition is in the OFF position.
2. Check the battery isolator is in the OFF position by turning anti-clockwise to release.

LIMITED WARRANTY

To take advantage of the MAKINEX limited warranty, you must have maintenance performed according to the maintenance schedule (contained in **Vanguard 61E377** owner's manual supplied with this product), by an authorised MAKINEX dealer or MAKINEX service technician. You are free to have your MAKINEX product serviced by any suitably qualified mechanic or electrician (depending on the mechanical or electrical requirement) and this will not affect your statutory warranties, however, failure by the owner to have the recommended servicing carried out by an authorised MAKINEX dealer/service technician means that you cannot take advantage of the MAKINEX limited warranty.

MAKINEX warrants each new generator to be free from defects in material and workmanship under normal domestic and industrial use and service for the period specified below, conditional to the limitations and exclusions printed on this page. This warranty applies only to new MAKINEX generator distributed by us and by our authorised MAKINEX dealers.

Under the limited warranty and at MAKINEX's discretion, upon evaluation, inspection and testing by a MAKINEX dealer or a MAKINEX service technician, MAKINEX will repair and replace of defective part(s).

AUSTRALIA: Our goods come with guarantees that cannot be excluded under the Australian Consumer Law. You are entitled to a replacement or refund for a major failure and compensation for any other reasonably foreseeable loss or damage. You are also entitled to have the goods repaired or replaced if the goods fail to be of acceptable quality and the failure does not amount to a major failure.

WARRANTY: (Ex-factory/ Reseller premise)

MAKINEX warrants to the original purchaser:

- Frame and all Electrical components will be free of defects in material and workmanship for a period of one year from the original date of purchase.
- Vanguard Engine is subject to 3 years warranty.
 - Please see www.briggsandstraton.com for details.
- 3 years warranty on RFL alternators

WARRANTY EXCLUSIONS

This warranty does not cover the following repairs and equipment:

NORMAL WEAR

Generator needs periodic service and genuine parts to perform well. This warranty does not cover repair when normal use has exhausted the life of a consumable part for example the oil filter and fuel filter.

INSTALLATION, USE, AND MAINTENANCE

This warranty will not apply to parts and/or labour if this generator is deemed to have been misused, neglected, involved in an accident, abused, loaded beyond the generator's limits, modified and installed improperly. Normal maintenance such as spark plugs, air filters, adjustments, fuel system cleaning and obstruction due to build-up is not covered by this warranty.

OTHER EXCLUSIONS

This warranty excludes:

- Maintenance services cost.
- Expedited freight costs.
- Cosmetic damage such as paint, decals, etc.
- Problems caused by accidents, improper storage, handling and shipping.
- Accessory parts such as starting batteries, fuses, spark plugs, and storage covers.
- Failures due to acts of God and other force majeure events beyond the manufacturer's control.
- Problems caused by parts that are not from the original manufacturer.

OWNER'S RESPONSIBILITY UNDER LIMITED WARRANTY:

Strict adherence to the maintenance checks and with **proof of scheduled maintenance history** is required by an authorised agent or qualified mechanic. It is the consumer's responsibility to deliver the machine in question to our service premises or to the premises of our appointed agent at the consumer's expense for replacement or repair as applicable. Maintenance services are not covered under warranty.

Claim Procedure:

- Contact MAKINEX by phone or email informing us of your machines problem or defect.
- Once the extent of the claim has been assessed, we retain the right to compensate the consumer for such defect, or repair (parts & labour), or replace the machine under warranty.
- All warranties will be carried out by MAKINEX authorised staff or appointed agents at a premise to be determined by the Manufacturer.
- It is the responsibility (and cost) of MAKINEX or our appointed agent to return the machine to be repaired or replaced under warranty to the consumer- this is valid for domestic territories only (e.g. Australian units will be delivered within Australian territories and European units will be delivered within its designated country's territories).
- Where the specific warranty component (e.g. Engine) is under a Manufacturer's warranty other than MAKINEX (e.g. Vanguard, Honda, Hatz or Kohler etc.), the consumer can contact either MAKINEX or the applicable manufacturer for repairs where such warranty was registered with that manufacturer at purchase.
- Warranty calls will only be carried out by our representatives and not via client's choice of repairer. We will not accept back charges for any work not carried out by our representatives or accept any charges due to equipment being un-operational for any reason even during its warranty period.

CONTACT INFORMATION

For sales, service, warranty and parts for all MAKINEX products; please refer below.

	SALES, SERVICE, SPARE PARTS & WARRANTY
AUSTRALIA	<p style="text-align: center;"><u>SALES</u></p> <p style="text-align: center;">TEL 1300 795 953 or +61 2 9460 8071 WEB www.makinex.com.au</p> <p style="text-align: center;"><u>SERVICE, SPARE PARTS & WARRANTY</u></p> <p style="text-align: center;">EMAIL service@makinex.com.au</p>
USA	<p style="text-align: center;"><u>SALES</u></p> <p style="text-align: center;">TEL +1 855-625-4639 WEB www.makinex.com</p> <p style="text-align: center;"><u>SERVICE, SPARE PARTS & WARRANTY</u></p> <p style="text-align: center;">EMAIL service@makinex.com</p>
UK	<p style="text-align: center;">WEB www.makinex.co.uk</p>
EUROPE	<p style="text-align: center;">TEL +31 (0)6 24881203 or +31 (0)6 50841849 EMAIL info@mtools.eu</p>
CHINA	<p style="text-align: center;">TEL +86 18951118278 EMAIL sales@makinex.com.cn</p>

Or your nearest MAKINEX distributor

We have very knowledgeable, experienced staff to assist you with help and advice.



APPENDICES

APPENDIX A – WIRING CIRCUIT DIAGRAM

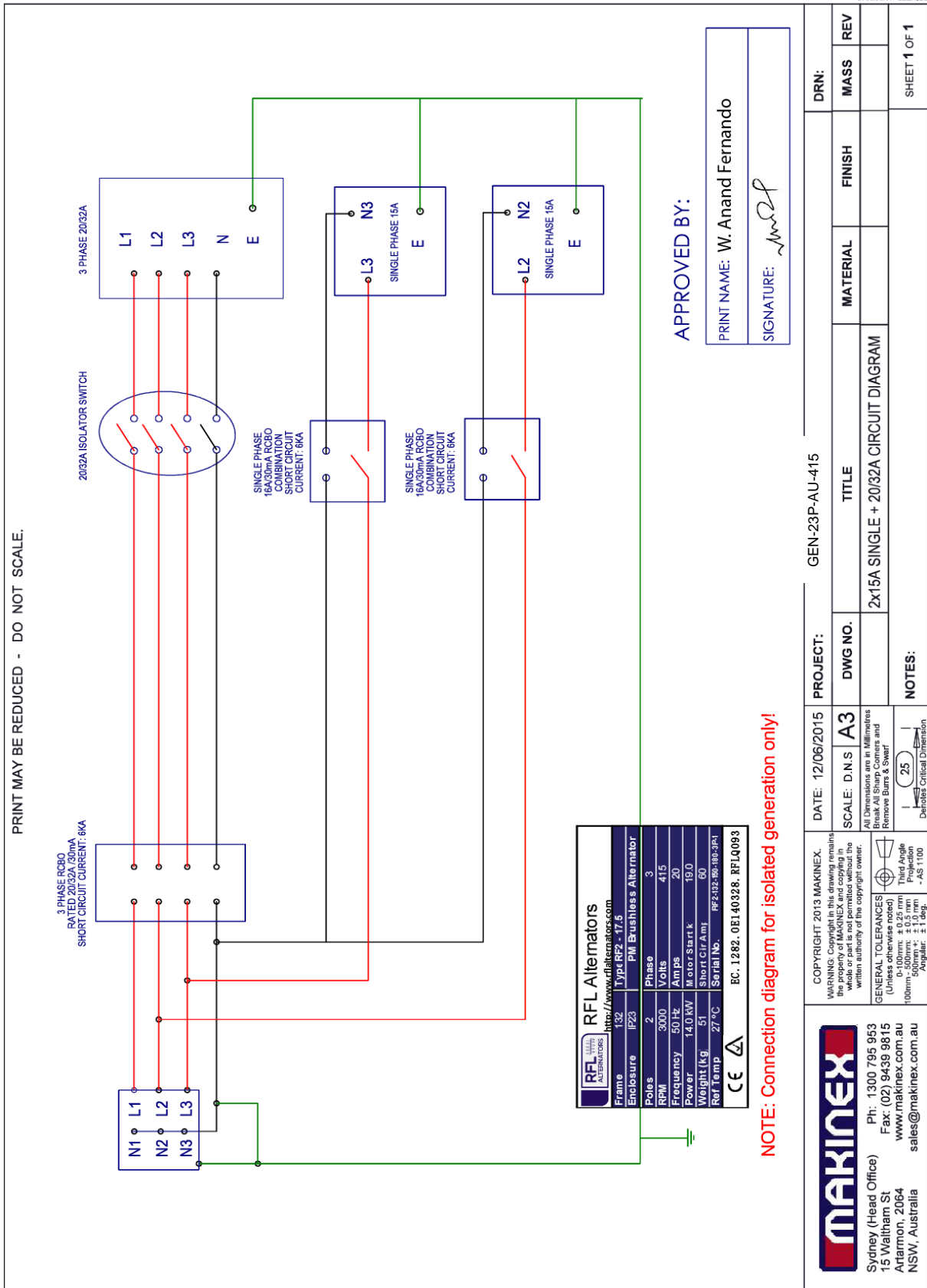

APPENDIX B – RISK ASSESSMENT

PRODUCT RISK / HAZARD ASSESSMENT TABLE

PRODUCT NAME: GEN-16P Generator	Assessment Carried Out By: Thomas Barua
MANUFACTURER: MAKINEX	Document Revision Number: 001
OPERATOR COMPETENCY: PLANT LICENCE NOT REQUIRED	Date Created: 05/012/2015

No:	TYPE / NATURE OF RISK or HAZARD	LIKELIHOOD		CONSEQUENCE		RISK LEVEL		CONTROL ACTION
		4	3	4	3	4	3	
1.0	1.1 PERSONAL INJURY – BURNS WHILST DOING MAINTENANCE ON MACHINE	2	4	4	NEGLIGIBLE	4	LOW	BE CAUTIOUS OF HOT PARTS (SUCH AS MUFFLERS), ALLOW TO COOL BEFORE MAINTENANCE/ADJUSTMENTS
	1.2 FIRE/EXPLOSION WHILST REFUELLING ENGINE	3	2	2	MAJOR	3	MEDIUM	SHUT OFF MACHINE AND ALLOW TO COOL BEFORE REFUELLING, NEVER REFUEL WHILE MOTOR IS RUNNING. DO NOT SMOKE AND ENSURE REFUELLING IS UNDERTAKEN IN WELL VENTILATED AREA (OUTSIDE, CLEAR OF IGNITION SOURCES)
2.0	2.1 ELECTROCUTION	3	1	1	FATALITY	2	HIGH	ENSURE THAT NO PART OF BODY IS IN CONTACT WITH TERMINALS WHEN STARTING / USING GENERATOR
	3.0	3.1 PERSONAL INJURY WHEN LIFTING/OR MOVEMENT ON SITE	2	2	2	MAJOR	HIGH	STAFF TRAINING ON CORRECT LIFTING PROCEDURE
4.0	3.2 STARTING PORTABLE GENERATOR	3	3	3	MINOR	4	LOW	MANUAL HANDLING TRAINING
	4.1 NOISE	3	3	3	MAJOR	3	MEDIUM	ALWAYS WEAR HEARING PROTECTION WHILST OPERATING AND/OR IN CLOSE VICINITY OF THE MACHINE

NOTES:

- > THIS PRODUCT HAS BEEN DESIGNED AND MANUFACTURED AS A GENERATOR ONLY
- > THIS DOCUMENT HAS BEEN PREPARED ACCORDING TO GUIDELINES AND RECOMMENDATIONS FOUND IN:
 1. HAZPAK PRODUCED BY THE WORK-COVER AUTHORITY AND THE AUSTRALIAN STANDARDS 4024.1.4/5 - 1996
 2. THE AUSTRALIAN STANDARDS - PART 1: GENERAL PRINCIPLES AUSTRALIAN STANDARD AS/NZS 3760 IN-SERVICE SAFETY INSPECTION AND TESTING OF ELECTRICAL EQUIPMENT.

"LIKELIHOOD LEVEL" REFERS TO THE PROBABILITY OF AN EVENT HAPPENING. THE FOLLOWING SCALE HAS BEEN USED TO DESCRIBE THE LIKELIHOOD OF A DEFINED RISK / HAZARD EVENT OCCURRING DURING NORMAL OPERATION OF THE EQUIPMENT. NOTE THAT LIKELIHOOD EVALUATION IS QUALITATIVE AND BASED ON BEST ESTIMATION VIA CONSULTATION AND EXPERIENCE:

1. VERY LIKELY
2. LIKELY
3. UNLIKELY
4. VERY UNLIKELY

"CONSEQUENCE" REFERS TO THE SEVERITY OF INJURY CAUSED DUE TO AN EVENT OCCURRING, USING THE FOLLOWING SCALE AS DEFINED BY THE "HAZPAK" DOCUMENT:

1. FATALITY = INJURES RESULT IN DEATH
2. MAJOR = NORMALLY IRREVERSIBLE INJURIES SEVERAL DAYS OFF
3. MINOR = REVERSIBLE INJURIES REQUIRING SEVERAL DAYS OFF
4. NEGLIGIBLE = ABLE TO BE TREATED USING FIRST AID

"RISK LEVEL" REFERS TO THE SEVERITY OF A RISK BASED ON THE "LIKELIHOOD LEVEL" AND "INJURY LEVEL". INHERENTLY, AS THE CONSEQUENCE INCREASES IN SEVERITY, RISK INCREASES - EVEN WHEN LIKELIHOOD IS LOW - THE FOLLOWING SCALE HAS BEEN USED:

1. HIGH = POTENTIAL DEATH, PERMANENT DISABILITY, OR MAJOR STRUCTURAL DAMAGE.
2. MEDIUM = POTENTIAL TEMPORARY, DISABILITY, OR MINOR STRUCTURAL DAMAGE.
3. LOW = POTENTIAL INCIDENT THAT HAS THE POTENTIAL TO CAUSE PERSONS TO REQUIRE FIRST AID.

